

品质源三凯 口碑自然来

PC+NMRV 带输入模块蜗轮减速机性能选型参数:

型号说明 / MODEL ILLUMINATE

PC-NMRV前置齿轮蜗轮蜗杆减速机/WORM GEARS WITH PRE-STAGE HELICAL UNITS

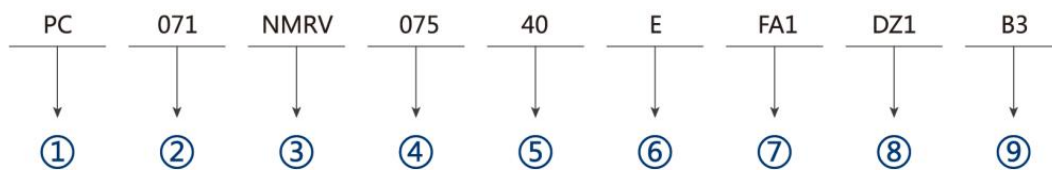

NO	说明	Comments
1	前置斜齿轮减速代号	Helical Pre-stage unit
2	电机座号	Motor frame size
3	型号代码： 1. RV孔输入带输入法兰 2. NRV轴输入不带输入法兰	Model code 1. NMRV:Hole input with flange 2. NRV:Shaft input without flange
4	减速机中心距（规格）	Central distance of worm gear units(spec)
5	减速机速比 (i=5,7.5,10,15,20,25,30,40,50,60,80,100)	Speed ratio of reducer r(i=5,7.5;10;15;20;25;30;40;50;60;80;100)
6	1. 无代号表示不带蜗杆同向尾出轴 2. E：带蜗杆同向尾出轴	1. No mark means single extension worm shaft 2. E: Double extension worm shaft
7	1. 无代号表示不带输出法兰 2. FA,FB,FC,FD,FE(1/2):输出法兰号和位置	1. No mark means without output flange 2. FA,FB,FC,FD,FE(1/2):output Flange and position
8	1. 无代号表示孔输出 2. DZ (1/2)：单向输出轴和位置 3. SZ：双向输出轴	1. No mark means hole output 2. DZ(1/2):Single output shaft and position 3. SZ:Double output shaft
9	安装方位代号	Installation position code

订单时请说明是否带电机，一般按不带电机供应。

When ordering, you should show whether the reducers are equipped with motors, otherwise reducers aren't supplied with motors.

公司名称：上海梁瑾机电设备有限公司

联系人：盛志豪 手机:15021432841

QQ:208611419

电话:021-60538381 传真:021-57872573

网址：<http://www.lianjin-blower.co> www.lijszh.com

地址：中国上海上海市松江区茜浦路 850 弄 33 号

PC+NMRV产品介绍 / DURING INTRODUCTION PC+NMRV



公司名称：上海梁瑾机电设备有限公司

联系人：盛志豪 手机:15021432841

QQ:208611419

电话:021-60538381 传真:021-57872573

网址：<http://www.lianjin-blower.co> www.lijszh.com

地址：中国上海上海市松江区茜浦路 850 弄 33 号

PC+NMRV尺寸 / SIZE OF PC+NMRV

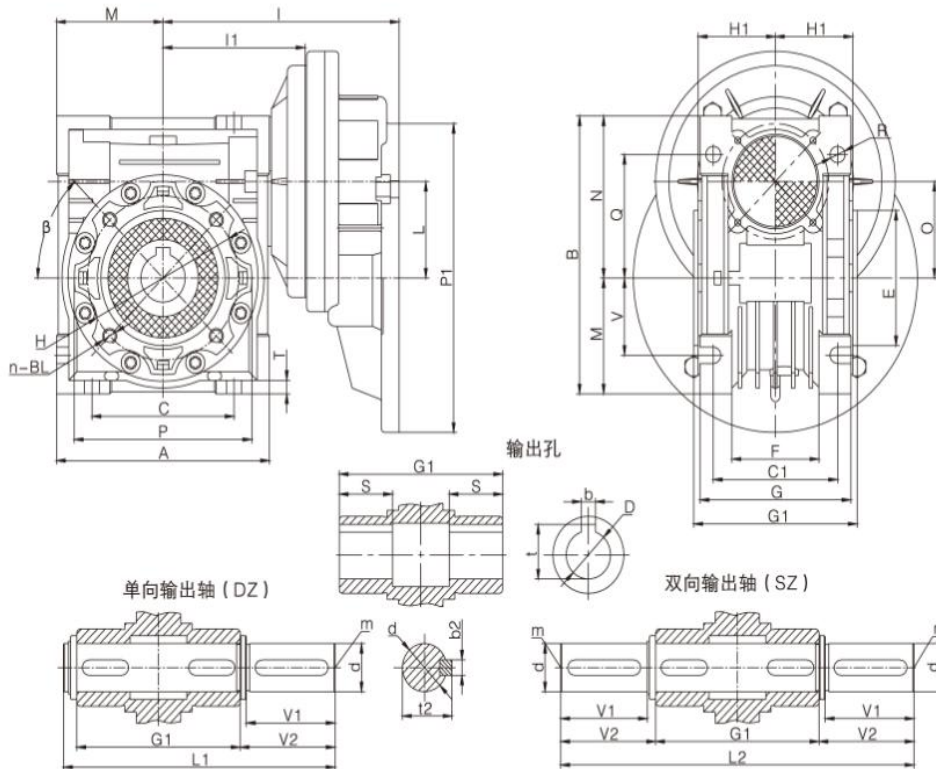

PC-NMRV	A	B	C	C1	D(H7)	E(h8)	F	G	G1	H	H1	I	I1	L	L1	L2	M	N	O	P	P1	Q	R
063-040	100	121.5	70	60	18(19)	60	43	71	78	75	36.5	115	70	40	128	164	50	71.5	40	87	140	55	6.5
063-050	120	144	80	70	25(24)	70	49	85	92	85	43.5	125	80	40	153	199	60	84.0	50	100	140	64	8.5
063-063	144	174	100	85	25(28)	80	67	103	112	95	53.0	140	95	40	173	219	72	102	63	110	140	80	8.5
071-050	120	144	80	70	25(24)	70	49	85	92	85	43.5	133	80	48	153	199	60	84.0	50	100	160	64	8.5
071-063	144	174	100	85	25(28)	80	67	103	112	95	53.0	148	95	48	173	219	72	102	63	110	160	80	8.5
071-075	172	205	120	90	28(35)	95	72	112	120	115	57.0	165.5	112.5	48	192	247	86	119	75	140	160	93	11
071-090	206	238	140	100	35(38)	110	74	130	140	130	67.0	182.5	129.5	48	234	309	103	135	90	160	160	102	13
080-075	172	205	120	90	28(35)	95	72	112	120	115	57.0	182	112.5	62	192	247	86	119	75	140	200	93	11
080-090	206	238	140	100	35(38)	110	74	130	140	130	67.0	199	129.5	62	234	309	103	135	90	160	200	102	13
080(090)-110	255	295	170	115	42	130	/	144	155	165	74.0	229.5	160	62	249	324	127.5	167.5	110	200	200	125	14
080(090)-130	293	335	200	120	45	180	/	155	170	215	81.0	248.5	179	62	265	340	146.5	187.5	130	250	200	140	16

PC-NMRV	S	T	BL	β	b	b2	t	t2	d(h6)	m	V	V1	V2
063-040	26	6.5	M6X8(n=4)	45°	6(6)	6	20.8(21.8)	20.5	18	M6	35	40	43.0
063-050	30	7	M8X10(n=4)	45°	8(8)	8	28.3(27.3)	28.0	25	M10	40	50	53.5
063-063	36	8	M8X14(n=8)	45°	8(8)	8	28.3(31.3)	28.0	25	M10	50	50	53.5
071-050	30	7	M8X10(n=4)	45°	8(8)	8	28.3(27.3)	28.0	25	M10	40	50	53.5
071-063	36	8	M8X14(n=8)	45°	8(8)	8	28.3(31.3)	28.0	25	M10	50	50	53.5
071-075	40	10	M8X14(n=8)	45°	8(10)	8	31.3(38.3)	31.0	28	M10	60	60	63.5
071-090	45	11	M10X18(n=8)	45°	10(10)	10	38.3(41.3)	38.0	35	M12	70	80	84.5
080-075	40	10	M8X14(n=8)	45°	8(10)	8	31.3(38.3)	31.0	28	M10	60	60	63.5
080-090	45	11	M10X18(n=8)	45°	10(10)	10	38.3(41.3)	38.0	35	M12	70	80	84.5
080(090)-110	50	14	M10X18(n=8)	45°	12	12	45.3	48.5	42	M16	85	80	84.5
080(090)-130	60	15	M12X21(n=8)	45°	14	14	48.8	53.5	45	M16	100	80	85.0

公司名称: 上海梁瑾机电设备有限公司

联系人: 盛志豪 手机:15021432841

QQ:208611419

电话:021-60538381 传真:021-57872573

网址: <http://www.lianjin-blower.co> www.lijszh.com

地址: 中国上海上海市松江区茜浦路 850 弄 33 号

PC-NMRV组合 / PC-NMRV COMBINATIONS

	i	PC 063		PC 071		PC 080			PC 090		
		105/11 i=2.93	105/14 i=2.93	120/14 i=2.94	120/19 i=2.94	160/19 i=3	160/24 i=3	160/28 i=3	160/19 i=2.45	160/14 i=2.45	160/28 i=2.45
NMRV040	25										
	30										
	40										
	50										
	60										
	80										
	100										
NMRV050	25										
	30										
	40										
	50										
	60										
	80										
	100										
NMRV063	25										
	30										
	40										
	50										
	60										
	80										
	100										
NMRV075	25										
	30										
	40										
	50										
	60										
	80										
	100										
NMRV090	25										
	30										
	40										
	50										
	60										
	80										
	100										
NMRV110	25										
	30										
	40										
	50										
	60										
	80										
	100										
NMRV130	25										
	30										
	40										
	50										
	60										
	80										
	100										

公司名称：上海梁瑾机电设备有限公司

联系人：盛志豪 手机:15021432841

QQ:208611419



电话:021-60538381 传真:021-57872573

网址: <http://www.lianjin-blower.co> www.lijszh.com

地址：中国上海上海市松江区茜浦路 850 弄 33 号

减速机选型表 / GEAR UNIT SELECTION TABLES

PC...NMRV...(n₁=1400r/min) 性能参数 PERFORMANCE PARAMETER

P _{1n} (kw)	n ₂ (r/min)	i	M _{2n} (Nm)	F ₁₂ (N)	f _s		
0.12	18.7	75	42	2833	1.2	PC063-NMRV040	6314
	15.6	90	46	3011	1.2		
	11.7	120	57	3314	0.9		
	9.3	150	66	3490	0.7		
	7.8	180	74	3490	0.6		
	9.3	150	68	4840	1.3	PC063-NMRV050	6314
	7.8	180	75	4840	1.1		
	5.8	240	88	4840	0.8		
	4.7	300	98	4840	0.7		
	5.8	240	92	6270	1.5	PC063-NMRV063	6314
4.7	300	103	6270	1.2			
0.18	18.7	75	64	2833	0.8	PC063-NMRV040	6324
	15.6	90	70	3011	0.8		
	11.7	120	85	3314	0.6		
	18.7	75	64	3889	1.4	PC063-NMRV050	6324
	15.6	90	71	4132	1.5		
	11.7	120	87	4548	1.1		
	9.3	150	101	4840	0.9		
	7.8	180	113	4840	0.7		
	5.8	240	133	4840	0.6		
	9.3	150	103	6270	1.7	PC063-NMRV063	6324
	7.8	180	117	6270	1.4		
	5.8	240	139	6270	1.0		
	4.7	300	155	6270	0.8		
	12.0	75	95	4506	1.2	PC071-NMRV050	7116
	10.0	90	105	4788	1.4		
7.5	120	126	4840	1.0			
0.25	12.0	75	97	5889	2.2	PC071-NMRV063	7116
	10.0	90	107	6259	2.4		
	7.5	120	131	6270	1.8		
	6.0	150	152	6270	1.4		
	5.0	180	168	6270	1.2		
	3.8	240	197	6270	0.9		
	3.0	300	218	6270	0.7		
	5.0	180	179	7380	1.7	PC071-NMRV075	7116
	3.8	240	211	7380	1.2		
	3.0	300	235	7380	1.0		
18.7	75	88	3889	1.0	PC071-NMRV050	7114	
15.6	90	98	4132	1.1			
11.7	120	121	4548	0.8			
18.7	75	91	5083	1.8	PC071-NMRV063	7114	
15.6	90	100	5401	2.0			
11.7	120	125	5945	1.5			
9.3	150	143	6270	1.2			
7.8	180	163	6270	1.0	PC071-NMRV063	7114	
5.8	240	192	6270	0.7			
4.7	300	215	6270	0.6			
12.0	75	135	5889	1.6	PC071-NMRV063	7126	
1.0	90	148	6259	1.8			

公司名称: 上海梁瑾机电设备有限公司

联系人: 盛志豪 手机:15021432841

QQ:208611419



电话:021-60538381 传真:021-57872573

网址: <http://www.lianjin-blower.co> www.lijszh.com

地址: 中国上海上海市松江区茜浦路 850 弄 33 号

减速机选型表 / GEAR UNIT SELECTION TABLES

PC...NMRV...(n₁=1400r/min) 性能参数 PERFORMANCE PARAMETER

P _{in} (kw)	n ₂ (r/min)	i	M _{2n} (Nm)	F _{r2} (N)	fs			
0.25	7.5	120	181	6270	1.3	PC071-NMRV063	7126	
	6.0	150	211	6270	1.0			
	9.3	150	151	7380	1.7			
	0.25	7.8	180	172	7380	1.4	PC071-NMRV075	7114
		5.8	240	201	7380	1.1		
		4.7	300	230	7380	0.9		
		12.0	75	139	6952	2.4		
		10.0	90	155	7380	2.5		
		7.5	120	191	7380	1.9		
	0.25	6.0	150	219	7380	1.5	PC071-NMRV075	7126
		5.0	180	248	7380	1.2		
		5.0	180	263	8180	1.9		
		3.8	240	318	8180	1.4		
		3.0	300	358	8180	1.1		
		18.7	75	134	5083	1.2		
0.25	15.6	90	148	5401	1.4	PC071-NMRV063	7124	
	11.7	120	185	5945	1.0			
	9.3	150	212	6270	0.8			
0.37	18.7	75	138	6000	1.8	PC071-NMRV075	7124	
	15.6	90	154	6375	1.9			
	11.7	120	191	7017	1.5			
	9.3	150	223	7380	1.1			
	7.8	180	254	7380	0.9			
	0.37	12.0	75	206	6952	1.6	PC080-NMRV075	8016
		10.0	90	230	7380	1.7		
		7.5	120	283	7380	1.3		
	0.37	6.0	150	324	7380	1.0	PC071-NMRV090	7124
		7.8	180	268	8180	1.5		
		5.8	240	321	8180	1.1		
		4.7	300	371	8180	0.9		
		6.0	150	347	8180	1.6		
		5.0	180	389	8180	1.3		
	0.37	3.8	240	471	8180	1.0	PC080-NMRV090	8016
3.8		240	509	10320	1.6			
3.0		300	577	10320	1.3			
0.55	18.7	75	205	6000	1.2	PC080-NMRV075	8014	
	15.6	90	230	6375	1.3			
	11.7	120	284	7017	1.0			
	9.3	150	332	7380	0.8			
	12.0	75	306	6952	1.1			
	0.55	10.0	90	341	7380	1.1	PC080-NMRV075	8026
		15.6	90	240	7054	2.3		
		11.7	120	297	7764	1.6		
	0.55	9.3	150	355	8180	1.3	PC080-NMRV090	8014
		7.8	180	398	8180	1.0		
		10.0	90	357	8174	2.0		
		7.5	120	441	8180	1.4		
		6.0	150	516	8180	1.1		
		5.0	180	578	8180	0.9		
	0.55	7.5	120	441	8180	1.4	PC080-NMRV090	8026
6.0		150	516	8180	1.1			
5.0		180	578	8180	0.9			

公司名称: 上海梁瑾机电设备有限公司

联系人: 盛志豪 手机:15021432841

QQ:208611419



电话:021-60538381 传真:021-57872573

网址: <http://www.lianjin-blower.co> www.lijszh.com

地址: 中国上海上海市松江区黄蒲路 850 弄 33 号

减速机选型表 / GEAR UNIT SELECTION TABLES

PC...NMRV...(n₁=1400r/min) 性能参数 PERFORMANCE PARAMETER



P _{1n} (kw)	n ₂ (r/min)	i	M _{2n} (Nm)	F ₁₂ (N)	fs			
0.55	7.8	180	425	10320	1.8	PC080-NMRV110	8014	
	5.8	240	513	10320	1.3			
	4.7	300	597	10320	1.0			
	0.55	7.5	120	462	10320	2.6	PC080-NMRV110	8026
		6.0	150	552	10320	2.0		
		5.0	180	620	10320	1.6		
		3.8	240	756	10320	1.1		
		3.8	240	756	13500	1.6		
3.0		300	858	13500	1.3	PC080-NMRV130		
0.75	18.7	75	280	6000	0.9	PC080-NMRV075	8024	
	15.6	90	313	6375	1.0			
	15.6	90	327	7054	1.7	PC080-NMRV090	8024	
	11.7	120	405	7764	1.2			
	9.3	150	483	8180	0.9			
	7.8	180	543	8180	0.7			
	11.7	120	430	9811	2.2	PC080-NMRV110	8024	
	9.3	150	506	10320	1.7			
	7.8	180	580	10320	1.3			
	5.8	240	700	10320	0.9			
	12.4	73	393	9614	3.2	PC090-NMRV110	90S6	
	9.3	96.8	508	10320	2.3			
	7.4	121	607	10320	1.8			
	6.2	145.2	682	10320	1.5			
	4.6	193.6	832	10320	1.0			
	5.8	240	712	13500	1.4			PC080-NMRV130
	4.7	300	813	13500	1.1	PC090-NMRV130	90S6	
	12.4	73	399	12575	4.4			
	9.3	96.8	508	13500	3.2			
	7.4	121	607	13500	2.6			
6.2	145.2	682	13500	2.1				
4.6	193.6	832	13500	1.5				
3.7	242	944	13500	1.2				
1.1	12.4	73	576	9614	2.2			PC090-NMRV110
	9.3	96.8	746	10320	1.6			
	7.4	121	890	10320	1.2			
	6.2	145.2	1000	10320	1.0			
	19.3	73	392	8298	2.5	PC090-NMRV110	90S4	
	14.5	96.8	508	9133	1.8			
	11.6	121	599	9838	1.5	PC090-NMRV110	90S4	
	9.6	145.2	686	10320	1.1			
	7.2	193.6	828	10320	0.8			
	12.4	73	585	12575	3.0	PC090-NMRV130	90L6	
	9.3	96.8	746	13500	2.2			
	7.4	121	890	13500	1.7			
	6.2	145.2	1000	13500	1.4			
	4.6	193.6	1220	13500	1.0			
	19.3	73	398	10853	3.5			PC090-NMRV130
	14.5	96.8	508	11945	2.6			
11.6	121	608	12868	2.0				

公司名称：上海梁瑾机电设备有限公司
 联系人：盛志豪 手机:15021432841
 QQ:208611419
 电话:021-60538381 传真:021-57872573
 网址: <http://www.lianjin-blower.co> www.lijszh.com

地址：中国上海上海市松江区茜浦路 850 弄 33 号

减速机选型表 / GEAR UNIT SELECTION TABLES

PC...NMRV...(n₁=1400r/min) 性能参数 PERFORMANCE PARAMETER

P _{in} (kw)	n ₂ (r/min)	i	M _{2m} (Nm)	F _{r2} (N)	fs					
1.1	9.6	145.2	686	13500	1.6	PC090-NMRV130	90S4			
	7.2	193.6	843	13500	1.2					
	5.8	242	962	13500	0.9					
1.5	19.3	73	535	8298	1.9	PC090-NMRV110	90L4			
	14.5	96.8	693	9133	1.3					
	11.6	121	817	9838	1.1					
	9.6	145.2	936	10320	0.8					
	1.5	19.3	73	542	10853	2.6	PC090-NMRV130	90L4		
		14.5	96.8	693	11945	1.9				
		11.6	121	830	12868	1.5				
		9.6	145.2	936	13500	1.1				
2.2	7.2	194	1149	13500	0.8	PC090-NMRV130	90L4			
	38.6	73	398	6586	2.1					
		28.9	96.8	516	7249			1.5		
		23.1	121	617	7809			1.2		
	38.6	73	409	8614	2.9			PC090-NMRV110	90L2	
		28.9	96.8	545	9481					2.0
		23.1	121	654	10213					1.6
19.3		145.2	752	10853	1.3					

公司名称：上海梁瑾机电设备有限公司
 联系人：盛志豪 手机:15021432841
 QQ:208611419
 电话:021-60538381 传真:021-57872573
 网址: <http://www.lianjin-blower.co> www.lijszh.com

地址：中国上海上海市松江区茜浦路 850 弄 33 号

PC与NMRV安装方位 / PC AND NMRV INSTALLATION POSITION

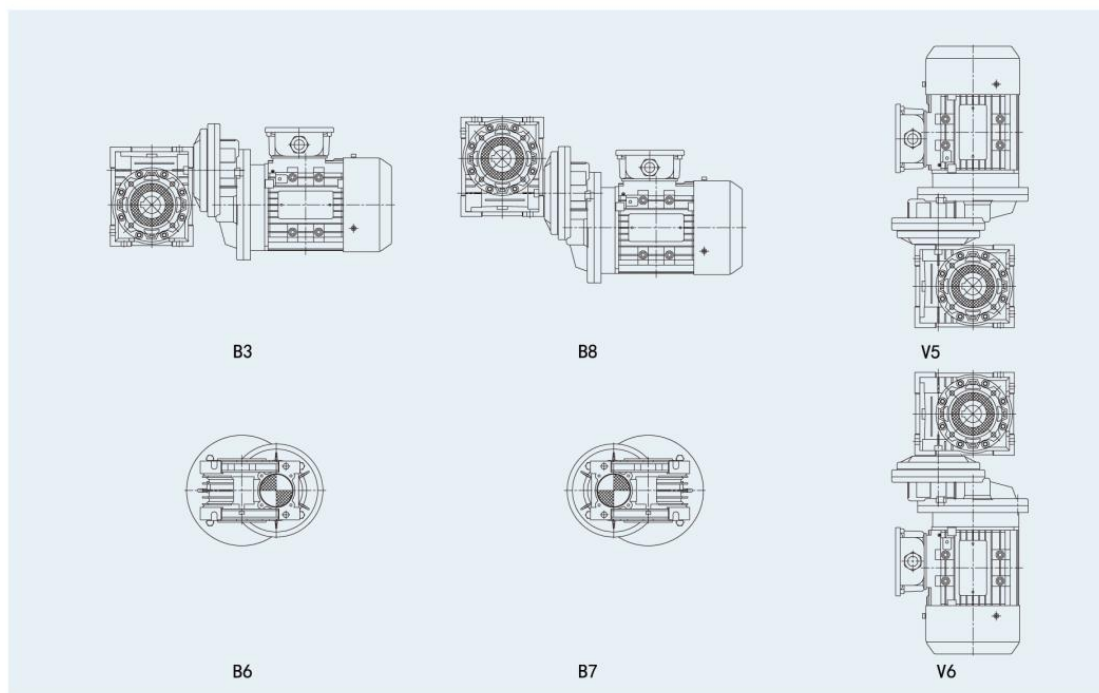

注：如没有特别说明，以B3为标准安装方式
Note: if there is no special instructions to B3 standards for installation.。